

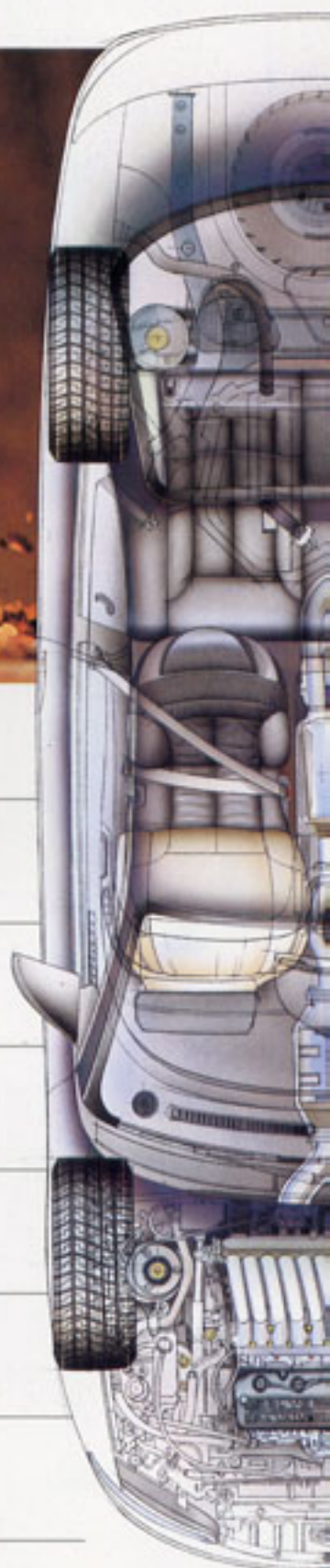

THE NEW DODGE

1 9 9 5

# AVENGER



A FRESH NEW SPORT COUPE

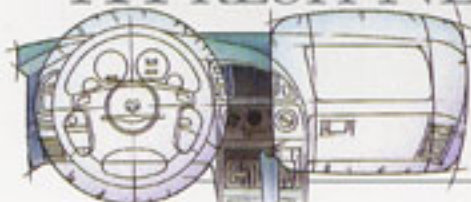

DUAL AIR BAGS

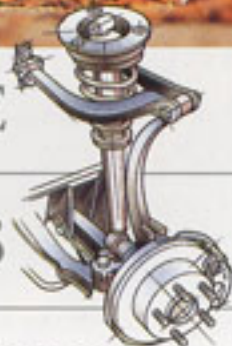

DOUBLE-WISHBONE SUSPENSION

CORNER-HUGGING RIDE

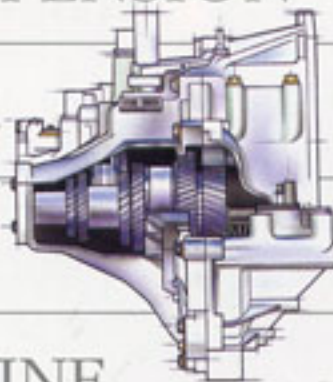

5-SPEED TRANSAXLE

MULTIVALVE DOHC ENGINE

ERGONOMIC

MASTERPIECE





Presenting the all-new Dodge Avenger sport coupe. Superbly engineered, it's a street-smart design from the pavement up — with a shape that flows *naturally* from substance. What it's all about is balance.

Avenger combines an intelligent mixture of contemporary technology that makes it a unique pleasure to drive and own. This is a genuine 2+2, with a "plus" all its own — an emphasis on style, comfort, and roominess.

Be assured that Avenger amply fulfills the traditional requirement of a sport coupe, which is expediting two people (and the occasional two or three others) from Point A to anywhere. Silky finesse over the road is mandatory. As are supportive seating and seductive appointments. A sensual silhouette goes without saying.

And Dodge makes affordable the performance of this nicely blended Avenger.

Driving experiences like the Avenger (and Viper, Intrepid, Neon, and Ram Pickup, to mention others) are an important part of the exciting changes taking place at The New Dodge.



The biggest changes at your Dodge dealer, however, have nothing to do with cars ... and everything to do with you, the customer.

Your perceptions of the dealership will determine whether you become a one-time buyer or a loyal Dodge customer for life. That's why we created Customer One, an ongoing training initiative that has already reached more than 100,000 factory, field and dealership personnel throughout the country.

This attitude awakening encompasses an array of highly effective programs dedicated to continuous improvement and a daily sensitivity to every customer's feelings. We ask every Dodge salesperson to become "certified" through completion of intensive product and human needs training. Our Mopar Service and Parts technicians work toward their Master's level proficiency rating and the MasterTech Golden Tool award. And our Owner Communications Program surveys every Dodge buyer and maintains an ongoing dialogue with you as a Dodge Avenger owner. So Chrysler and its Dodge dealerships are working and training to bring you a positive experience each time we serve you.



A sensual silhouette goes without saying.

---



*Avenger ES shown in Black.*



Avenger values interior volume, comfort and convenience.



Before Avenger, sport coupes too often extracted a severe comfort and convenience penalty with their tilt toward performance. Avenger's emphasis is on the brighter side of sportiness, with a smooth mixture of style, luxury, roadability, and usefulness. Here, the focus is on a Dodge design triumph of interior volume over exterior dimension.

Think of it as a 2+2 "plus." Both Avenger models, ES and Highline, share an abundant 104.2-cubic foot interior where everything is very ergonomic. Which means that we are obsessive about complementing the interface between people and machine.

Avenger carries two, plus two or three others, plus a lot of luggage (13.1 cubic feet) in a lockable trunk, with a folding rear seatback provision for awkwardly shaped items. Avenger ES includes a cargo net in the trunk to prevent luggage tumble and slide.



Seats that satisfy your shape. Standard on Avenger is a new series of front seats that easily adjust to conform to you. (The ES model also includes manually adjustable lumbar support.) These seats are but two of the many reasons Avenger is such a delight to drive long distances.

Comfort is convenience. Thoughtful design means understanding the ways people adjust to their cars. A glance at Avenger's control positioning suggests that this is one machine into which you settle naturally. Careful attention has been paid to access, shape, and activation. Switch surfaces have been rounded off, and they're composed of a flexible material that "gives" on contact. These are controls that make Avenger more responsive to your control.



Avenger's interior volume is created in no small way by transverse-mounted engines and front-wheel drive.

**V6 standard on ES.** A 24-valve, overhead cam (OHC) 2.5-liter V6 with sequential multipoint electronic fuel injection provides a responsive 155 horsepower at 6,000 rpm and a strong 161 pound-feet of torque at 4,800 rpm.

**Available automatic transaxle** (standard on ES model). Four-speed electronically controlled with overdrive for improved highway performance and reduced engine wear.

**Standard Highline engine** is a marvel of contemporary engineering. With dual overhead cams (DOHC) and 16 valves, its 2.0 liters develop 140 horsepower at 5,850 rpm—better than one horsepower per cubic inch.

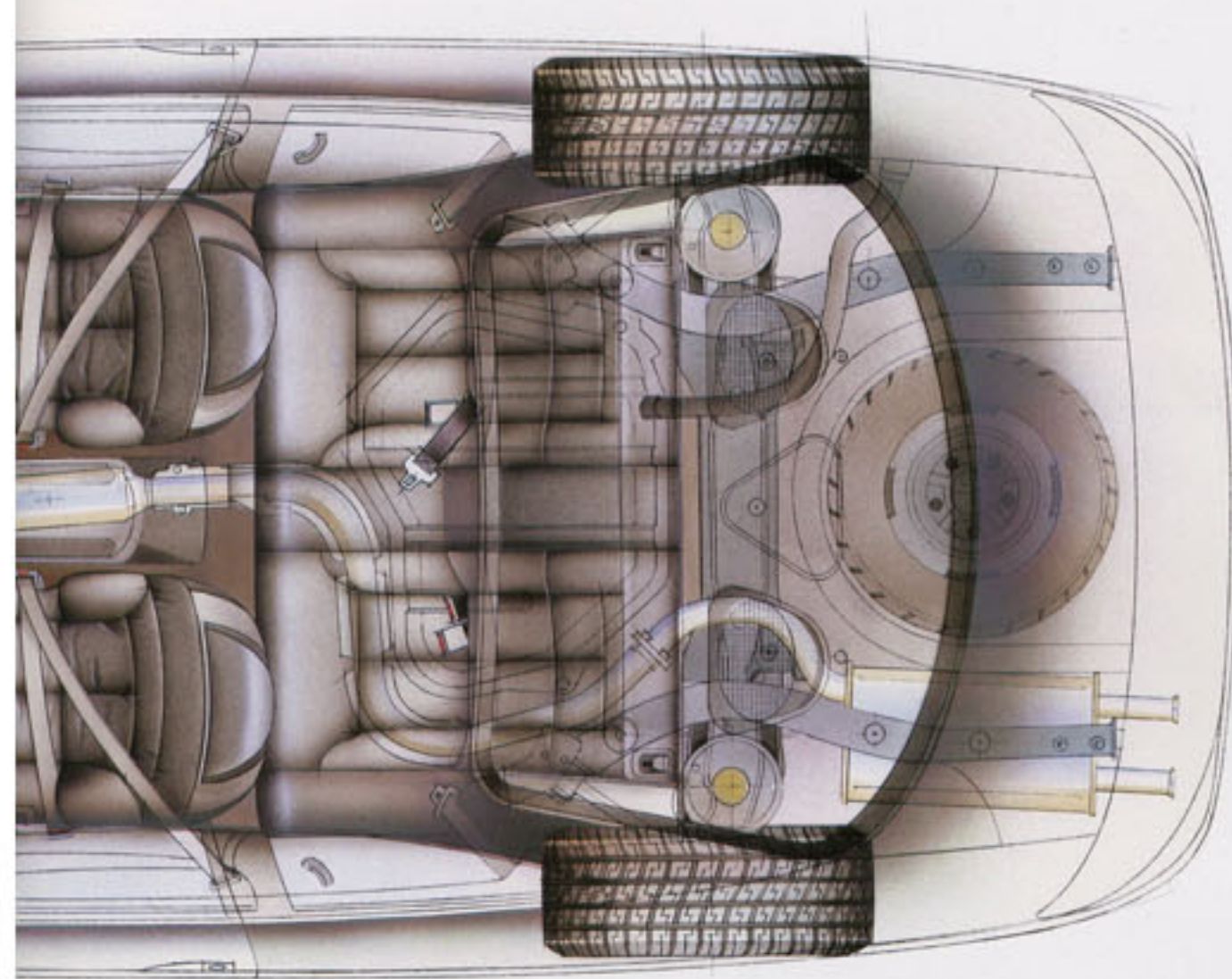
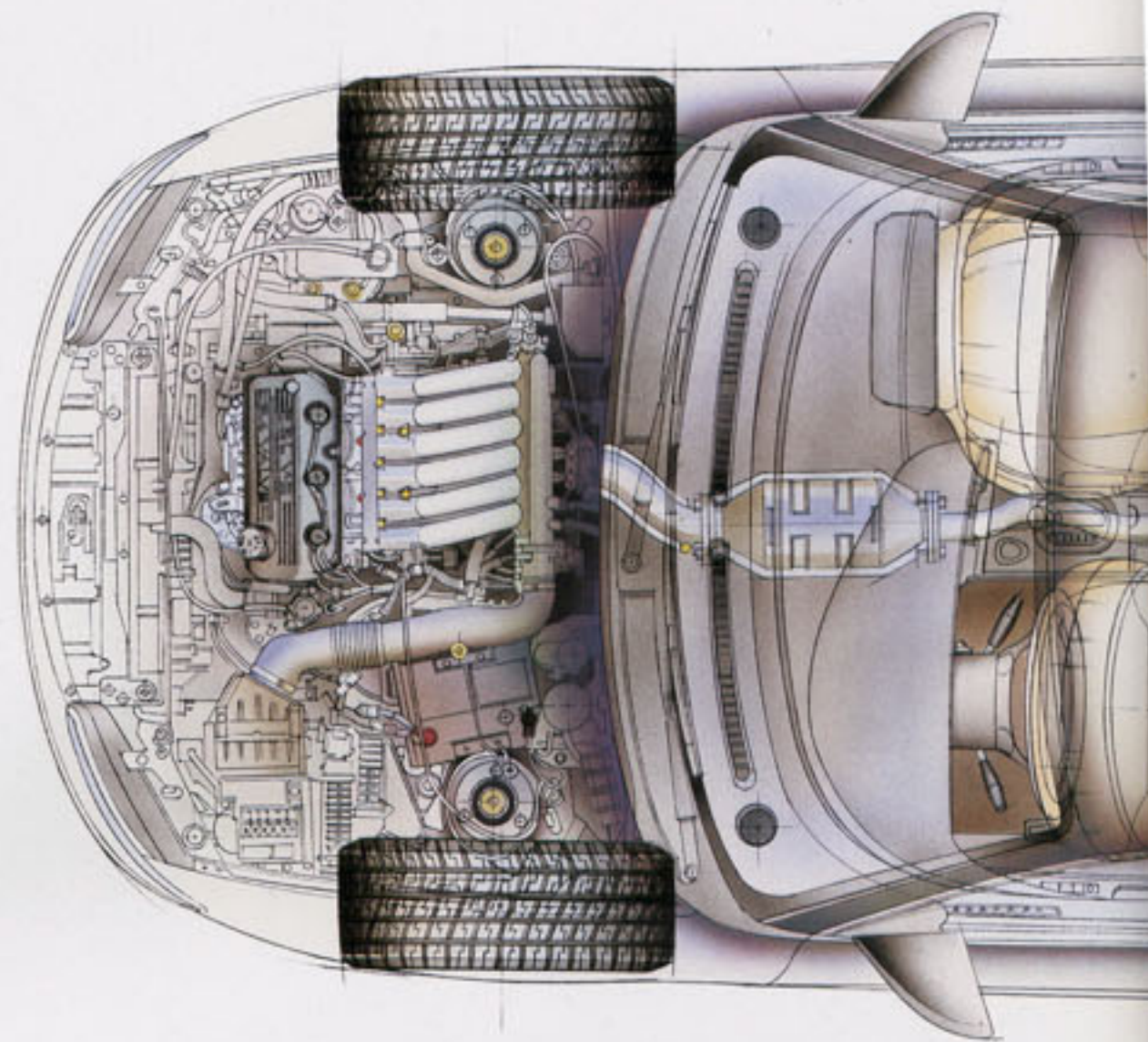

**Stainless steel exhaust system** runs from the manifold to the rear of Avenger and includes the muffler, providing ruggedness and rust-resistance.

**Standard electric rear window defroster** improves rear visibility and shuts off automatically after 10 minutes.

**Convenient, large trunk.** With 13.1 cubic feet, Avenger's trunk provides advantages over a hatchback — valuables are out of sight and fold-down rear seatbacks accept awkwardly shaped items (like skis).

**Major corrosion resistance.** Galvanized steel of Avenger's coachwork has been treated to protect all body panels (and their finish) from the ravages of the road, as well as the environment.

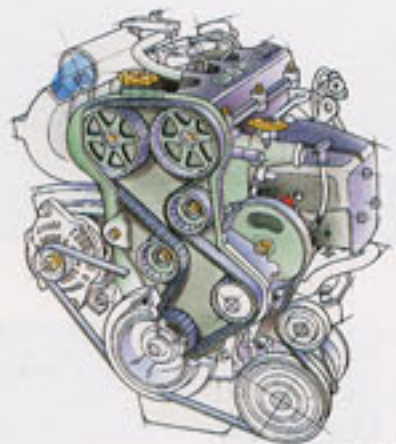

The front suspension's double-wishbone components promote excellent tracking, superb high-speed stability, and crisp, linear steering response.

Four-wheel disc antilock brakes are standard on Avenger ES, available on Highline. They significantly improve stability and maneuverability during hard braking.

The driver-side air bag\* is concealed behind the center of the steering wheel and fully deploys within 25 milliseconds of 14 miles per hour frontal barrier impacts.

The large passenger air bag\* folds in 35 milliseconds of the door is covered that matches the panel.

Located on the B-pillar, the outboard front shoulder belts are height adjustable through five positions by manually moving the turning loop.

Avenger's generous interior volume provides a rear seating area in which adults can actually feel comfortable. Check the leg, hip, and head room.

Newly developed rear suspension features a double-wishbone design, reducing road noise and vibration while assuring sure-footed roadability in the corners.

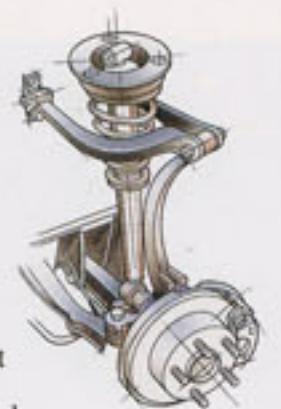

**A different sort of sport coupe.** Avenger has been designed to provide a remarkable new balance between style, comfort, performance, and a lean, satisfying utility. It comes to you from a company that is prepared to take a fiercely independent look at how cars are conceptualized.

**The New Dodge — new engines.** Avenger's more powerful engine is exclusive and standard to the top-of-the-line ES model. This 2.5-liter overhead cam V6 is modern, lightweight, and efficient. An all-new and fully contemporary 2.0-liter double overhead cam four-cylinder engine with 16 valves is standard on Avenger Highline models—backed by a standard five-speed manual transaxle designed for short, smooth, precise shifting.



**A consummate blend of ride and handling.** It's found in fully independent front and rear suspensions, surprising in such an affordable sport coupe. The goal here was to delete the harsh vibration and road surface-sensitive setups plaguing many less sophisticated 2+2s — while retaining a high level of responsiveness.

Avenger does it by locating all four wheels with a double-wishbone suspension featuring a high-mounted upper control arm, lower arm, and trailing arm that form a highly desirable, virtual kingpin axis. The result is generous wheel travel, European-like on-center steering, with consistent camber and castor providing "bite" in the turns. That means a flat cornering attitude, superior traction, low

noise, and minimal road vibration.

\*Always wear your seat belts.



Presenting Avenger Highline: complete, competent, even more affordable.



Avenger Highline shown in Deep Green Metallic.



Avenger Highline shown in Blue Metallic.

The intelligence of a design can be measured by its standard equipment. The Avenger Highline model is capable of delivering the road to you in a hushed rush. Yet it's not only competent, it's complete.

Highline passengers will appreciate the same ease of entry to the same spacious rear seating capacity as the ES model — the rear leg, hip, and shoulder room that is so uncommon to terrific-

looking sport coupes. Drivers will appreciate the many packaging possibilities presented by the split-folding rear seatbacks, which make allowances for the type of sporting gear, like skis or scuba tanks, sport coupe drivers like to transport.

A short, sweet list of options can be installed on either Highline or ES, even though both models are nicely equipped to begin with, so be sure to ask your dealer for information about the following very special additions.

**Optional Infinity stereo CD**, shown at bottom right. This AM/FM compact disc player is a complete sound system with five-band equalizer, remote amplifier, and eight Infinity speakers strategically positioned



throughout the interior for accurate concert hall reproduction. You are front row center, on the aisle.

**Standard on ES**, and available for Highline, an AM/FM cassette stereo radio (not shown) is electronically tuned with seek feature. The tape player has auto reverse, locking fast forward, and rewind. Twenty stations are programmable (10 AM and 10 FM).

**Remote six-disc CD changer**. Available as a dealer-installed option, this trunk-mounted compact disc changer (shown at center left) has a CD play/selector that's already built into the Infinity stereo system for good looks and ease of operation. Choose the music you prefer, and play it in the order you preselect.

**Available power sunroof** was designed to barely disturb the airflow over Avenger — even when open.

**Available safe and easy access**. Avenger's optional, key ring-activated electronic remote keyless entry system and vehicle theft security alarm are examples of our desire to make available every possible security item for your peace of mind.

**Stellar cellulars**. Your local Dodge dealer can provide a variety of cellular communications options. Your Avenger is ready to be equipped with such a unit. Ask your salesperson for details.



## WHAT ABOUT LEASING?

Leasing continues to grow in popularity — last year one out of every five new vehicles delivered was leased rather than purchased or traditionally financed.

Leasing as an alternative to financing provides a number of benefits. There's no down payment, just a security deposit and the first month's lease payment at delivery. Lower monthly payments are realized because you only pay for the time you actually use your vehicle. Since you choose the terms, leasing can also let you drive a new car more often. And you could move up to a higher-priced vehicle with extra options as well.

Your Dodge dealer can show you what a lease tailored to your own specifications can do for you. Please ask about Chrysler's own Gold Key Plans.

Dodge Avenger is covered by the Customer One Care\* plan, including:



**A 3-year or 36,000-mile (whichever comes first) Bumper-to-Bumper Limited Warranty** which covers the complete vehicle against defects in factory-supplied materials and workmanship. (This 3/36 warranty excludes tires, wiper blades, clutch and brake linings, and normal maintenance items.†)

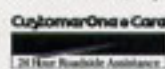

**Roadside Assistance for 3 years or 36,000 miles** providing 24-hour, 7-day-a-week Emergency Road Service, contacted by a 24-hour nationwide toll-free phone number. Roadside Assistance covers many items not included in the warranty, such as lockout, jump start, out of gas, flat tire repair and towing.‡

**A 7-year or 100,000-mile Outer-Panel Rust-Through Limited Warranty** which covers the cost of all parts and labor needed to repair exterior sheet-metal panels perforated by corrosion.

The 336 Customer One Care plan stays with the vehicle, and transfers automatically to any subsequent owners at no charge during the warranty period.

\*See your dealer for additional details and a copy of this limited warranty.  
†Tires and optional cellular phones are covered by their respective manufacturer's warranties.  
‡Roadside Assistance services provided by Cross Country Motor Club, Inc. (In California, Cross Country Motor Club of California, Inc.)



Additional peace-of-mind protection for vehicle owners is available through optional Chrysler Service Contracts. These services are available in a variety of time and mileage combinations to meet your particular driving needs.

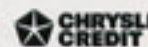

Chrysler Credit offers a broad range of traditional automotive financing plans and flexible terms for qualified buyers. Many of these plans can be customized to fit your particular budget and lifestyle. Our College Graduate Plans, for example, are especially attractive to those just beginning their careers. Or to make your new vehicle even more affordable, you may want to consider Gold Key Lease and Gold Key Plus short term financing.



Mopar parts are engineered by Chrysler Corporation for use in your new Dodge Avenger. When replacement is necessary, be sure to specify Mopar parts. Used by professional automotive technicians worldwide.

### MOPAR ACCESSORIES

Here is a partial list of popular Mopar accessories for Avenger. See your dealer for a complete list. • Car Cover • Adjustable Cargo Tray • Molded Cargo Tray • Six-Disc Compact Disc Changer • Door Edge Guards • Removable Roof Rack with Ski Carrier • Removable Roof Rack with Bike Carrier • Vinyl Hood Cover • Wheel Locks



### BUY YOUR CAR PHONE WHERE YOU BUY YOUR CAR

For 1995, Chrysler will be offering a selection of dealer-installed/supplied cellular phones in several models to enhance the available optional equipment list. OKI™ and Chrysler Cellular Systems warrant and service these products. Restrictions apply. Ask your dealer for details and a copy of these limited warranties.



### AUTOMOBILITY PROGRAM (formerly P-CAP)

Cash reimbursement is available for qualified adaptive driving devices on the 1995 Dodge Avenger. Ask your dealer to provide you with more information or call the Automobility Headquarters at 1-800-255-9877.

Planned and Designed by Dodge... a division of Chrysler Corporation. Engineered by Dodge and Mitsubishi Motors Corporation. Manufactured by Diamond-Star Motors in Normal, Illinois, U.S.A.

All product illustrations and specifications are based upon current information at the time of publication approval. Although descriptions are believed correct, complete accuracy cannot be guaranteed. Chrysler Corporation reserves the right to make changes from time to time, without notice or obligation, in prices, specifications, colors and materials, and to change or discontinue models. See your dealer for the latest information.

The New Dodge and Mopar are registered trademarks, and Avenger is a trademark of Chrysler Corporation.

Always wear your seat belts.

Form No. 74-383-9513



8/94 (225M)

Litho in U.S.A.

# THE NEW DODGE



Grand Caravan



Caravan



Intrepid



Avenger



Stratus



Neon Sedan



Neon Coupe



Stealth



Viper